







# TRESTON

## KOKOONPANO-OHJE ASSEMBLY INSTRUCTION

## TUOTANTOVAUNU INDUSTRIAL TRACK

25 -01- 2006

Koodi/code: **O-5886A**  
Sivut/Pages: 1/1  
Pvm/Date: 25.1.06  
Hyv./Acc.: *[Signature]*

No.	Part	Code	Pcs
1	 Kuusiokoloruuvi M8x12 Hex socket head cap screw M8x12	2530	4
2	 Kuusiomutteri M8 Hexagon nut M8	0796	4
3	 Aluslaatta M8 Washer M8	0833	4
4	 Jalkatulppa 80x40 Plug 80x40	2652	4
5	 Poraruuvi 4,2x13 Zn Drill screw 4,2x13 Zn	0767	1
6	 Tähtialuslaatta M8 Shaice proof washer M8	0843	1

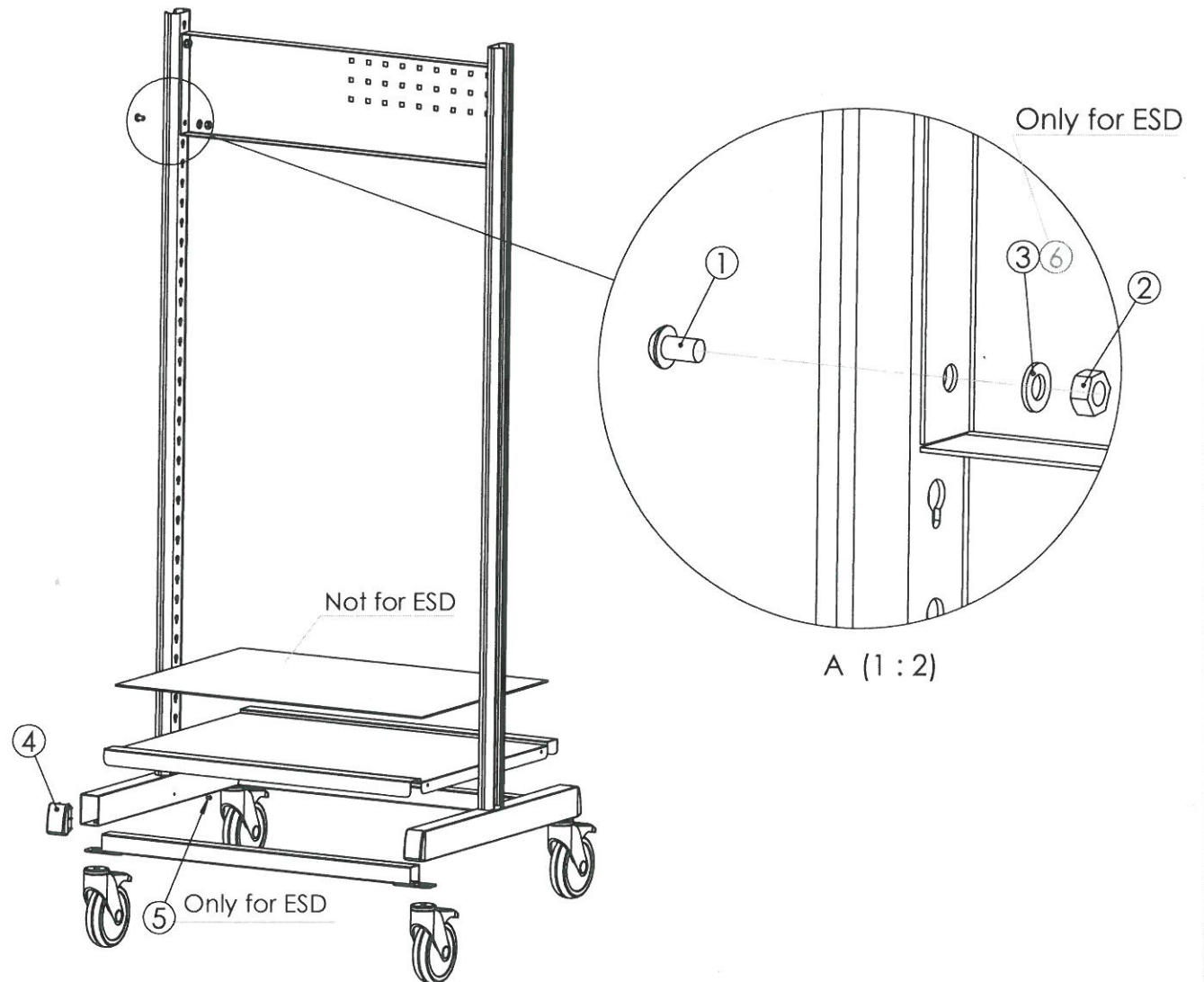

Alatason kantavuus max. 50 kg tasaista kuormaa.  
Bottom self load capacity max. 50 kg u.d.l.

Vaunun kantavuus lisävarusteilla max. 150 kg.  
Track load capacity with accessories max. 150 kg.

**IT 170 , IT 170 ESD**