









TRESTON

KOKOONPANO-OHJE
ASSEMBLY INSTRUCTION

TYÖPÖYTÄ
WORKBENCH

Koodi/code: **O-5861**
Sivut/Pages: 1/2
Pvm/Date: 27.12.04
Hyv./Acc.: 

No.	Part	Code	Pcs
1	 Yleisruuvi 5x50 Universal screw 5x50	0760	11
2	 Kuusiokoloruuvi M10x20 Hex socket head cap screw M10x20	0806	5
3	 Vastapala M10 Threaded plate M10	0827	5
4	 Lukkoruuvi M6x50 Cap square bolt M6x50	0812	11
5	 Kuusiomutteri M6 Hexagon nut M6	0795	11
6	 Tähtialuslaatta M6 Shaice proof washer M6	4042	11
7	 Aluslaatta M6,4 Plain washer M6,4	0832	11

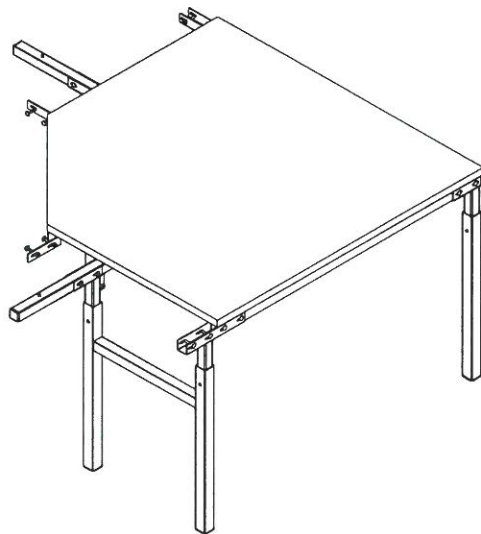

TP- (707, 909)KK / ESD
TPH- (707, 909)KK / ESD

