













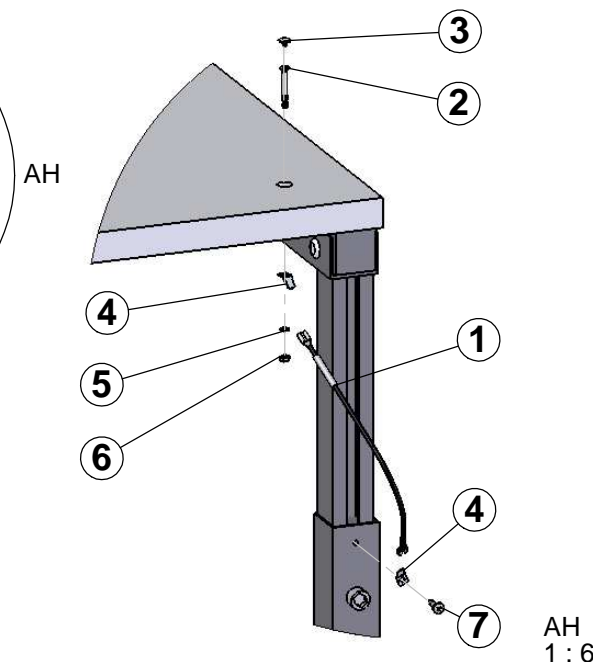
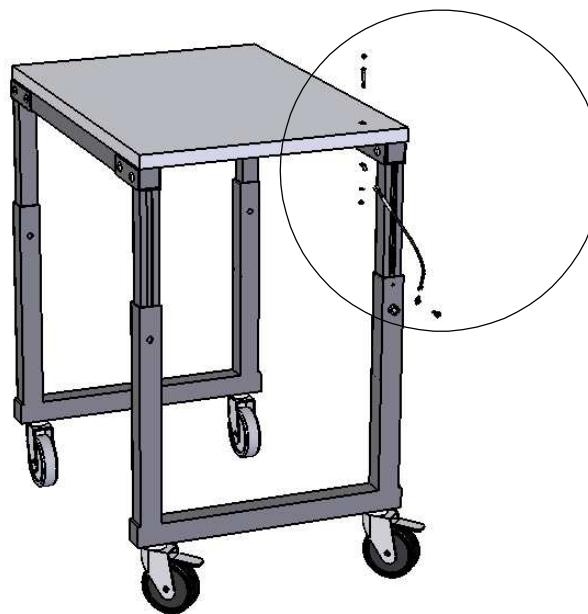

SAP 507ESD SAP 710ESD SAP 715ESD

①		L = 500 mm 1MΩ (1803)	1 x
②		M4, L = 33 mm	1 x
③		2,5 x 5	1 x
④		6,3 x 0,9 (45°)	2 x
⑤		4,3	1 x
⑥		M4	1 x
⑦		3 x 9,5	1 x



AT 507ESD AT 710ESD

①		L = 200 mm (1801)	1 x
②		M4 x 33 mm	1 x
③		2,5 x 5	1 x
④		6,3 x 0,9 (45°)	2 x
⑤		4,3	1 x
⑥		M4	1 x
⑦		3 x 9,5	1 x

